

# INSTRUCTION/INSTALLATION SHEET

## ALC DESIGNER SCENE SWITCH AND IR SCENE SWITCH

1154 Jordan Road  
 Lyman, SC 29365  
 Phone (864) 663-0013 Fax (864) 663-0018  
 www.genesis13lighting.com

IS-0283 REV. B

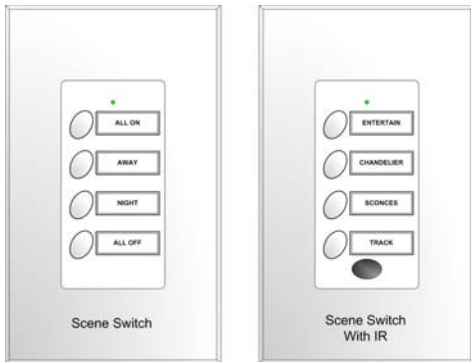

Figure 1. ALC Designer Scene Switch and Designer IR Scene Switch

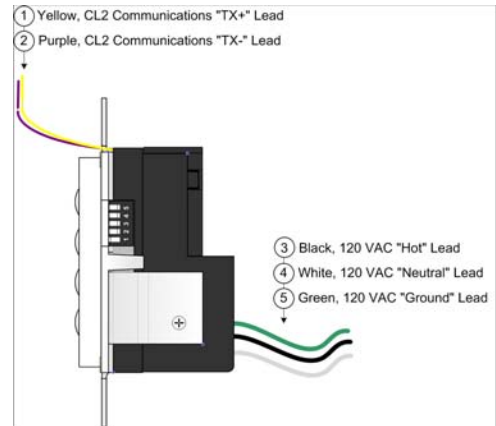

Figure 2. ALC Designer Scene Switch Lead Connections

### 1. Introduction

The part no. 364720 ALC Designer Scene Switch provides scene lighting and system mode control capability when installed and operated within an Genesis Home Lighting, On-Q HMS, HAI OMNI, ELK-M1 or RCS CommStar system. The part no. 364720 Scene Switch incorporates four pushbuttons that may be programmed to provide independent system control functions. Descriptive labels are provided with each switch to identify the system function of each pushbutton. The part no. 364776 ALC Designer IR Scene Switch functions identically to the part no. 364720 Scene Switch but incorporates the additional capacity to be controlled by four pre-programmed Infrared (IR) remote control codes. Each of the four IR codes is unique and when received, corresponds to the press of an individual pushbutton. The part no. 364820-01 universal IR learning remote control incorporates four factory programmed buttons; AUX-1, AUX-2, AUX-3 and AUX-4 that when pressed, transmit the required IR control codes. These IR codes can be re-programmed into any learning IR remote control.

### 2. Compliance

The ALC Designer Scene Switches are FCC, Part 15, Class B verified and are UL listed. When installed as directed, installations comply with the installation and wiring practices of the NFPA 70 2005 National Electrical Code.

### 3. Installation

A UL Class 2 (CL2) rated multi-conductor communication cable and uninterrupted source of 120 VAC must be present at each switch location. Category 3, 5 or 5E cable is recommended for CL2 communication and control.

**DANGER: To avoid risk of fire or shock, turn off the power at the circuit breaker or fuse. Test to be sure the power is off before wiring.**

#### Installation Procedure

- Step 1: Verify that 120 VAC power has been removed at the circuit breaker or fuse.
- Step 2: Retrieve the CL2 communication and control cable.
- Step 3: Retrieve the 120 VAC cable.
- Step 4: Remove 0.3 in. of insulation from the communication cable's blue and blue/white conductors, as shown in Figure 4.
- Step 5: Remove the pre-cut insulation from the Scene Switch's 120 VAC leads and CL2 communication leads.
- Step 6: Connect the 120VAC leads from the switch to the 120VAC source.

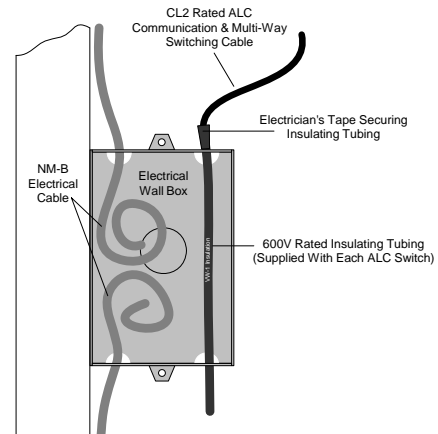

Figure 3. Cable Installation Rough-In

**NOTE: ALC Switches must be installed and operated in accordance with all electrical codes and regulations.**

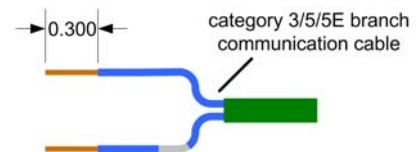
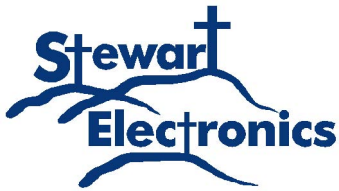

Figure 4. Preparing Communication Conductors

Step 7: Connect the ALC communication conductors with the included splice connectors. The Switch's purple TX- lead should be connected to communication cable's blue conductor and the Switch's yellow TX+ lead should be connected to communication cable's blue/white conductor as shown in Figure 5.



# INSTRUCTION/INSTALLATION SHEET

## ALC DESIGNER SCENE SWITCH AND IR SCENE SWITCH

1154 Jordan Road  
 Lyman, SC 29365  
 Phone (864) 663-0013 Fax (864) 663-0018  
 www.genesis13lighting.com

IS-0283 REV. B

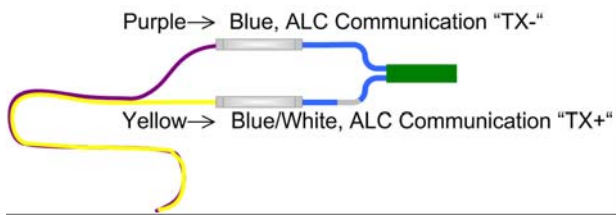

Figure 5. ALC Communication Connections

Step 8: Push the communication cable back into the wall and position the CL2 conductors to allow flush installation of the ALC module to the finished wall surface. Fasten the Scene Switch into the wall box with the screws provided. See Figure 6.

**CAUTION:** Ensure that all conductors remain completely insulated and do not become pinched between the ALC module's metal yoke and the wall surface, outlet box or cover plate. Any shorts caused by piercing of a conductor's insulation will cause loss of operation.

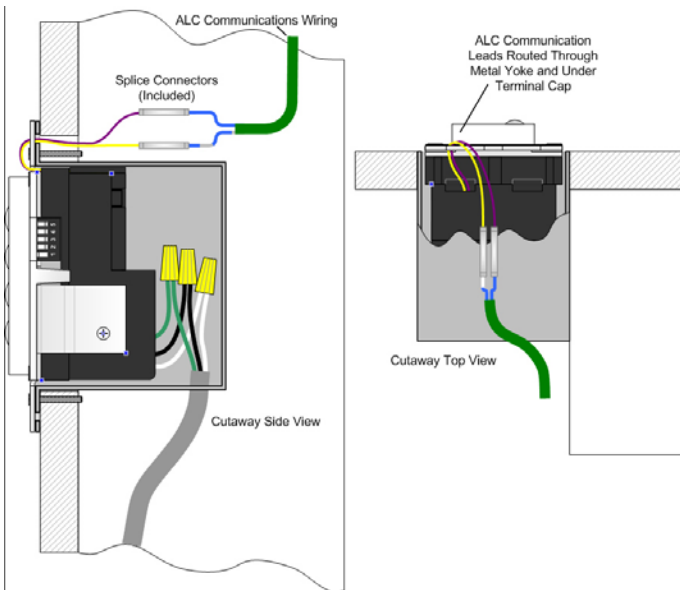

Figure 6. Recommended Installation Method

Step 9: Set the Switch's unit address. Each ALC communication wiring branch may include up to 31 uniquely addressed ALC devices. All ALC devices residing on the same communication wiring branch must be assigned unique unit addresses. The unit address is set via the 5-position DIP switch on the side of each ALC device. Figure 7 depicts unit address no. 1: position 1 = up, position 2-5 = down. Figure 8 depicts the address DIP switch configurations for all unit address settings; 1–31.

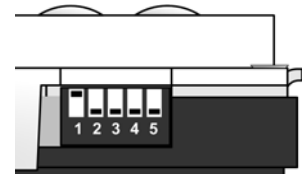

Figure 7. ALC Address DIP Switch

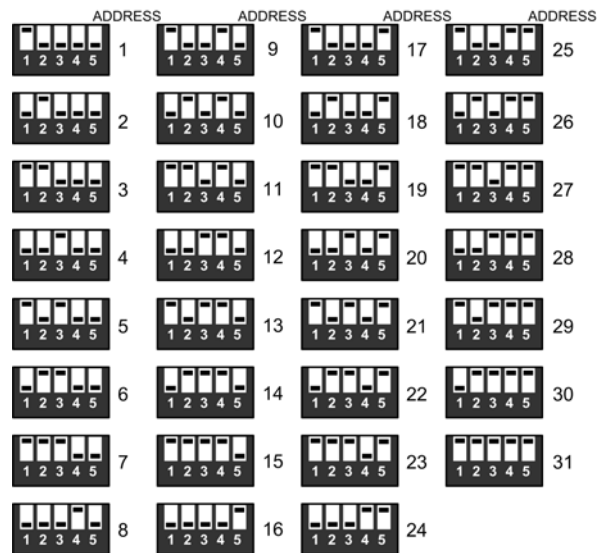

Figure 8. ALC Unit Addresses

Step 10: Label the Scene Switch Buttons. Remove the lenses beside each button by inserting a small tool, such as a paper clip, into the holes on the side of the bezel. Refer to Figure 9. After the lenses have been removed, apply any of the provided descriptive labels. Replace the lenses.

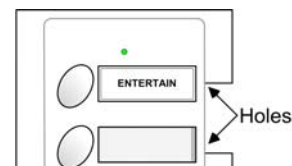

Figure 9. Lens Release Locations

Step 11: Install decorator style switch cover plate.  
 Step 12: Apply power to the 120 VAC electrical lighting/power circuit.

**CAUTION:** Verify all wiring connections and terminations prior to applying 120 VAC power to the Scene Switch. Electrical shorts will result in destruction of the Scene Switch. Misapplication will void the product warranty.



# INSTRUCTION/INSTALLATION SHEET ALC DESIGNER SCENE SWITCH AND IR SCENE SWITCH

1154 Jordan Road  
Lyman, SC 29365  
Phone (864) 663-0013 Fax (864) 663-0018  
www.genesis13lighting.com

## IS-0283 REV. B

### Alternate Installation Method

Figure 10 depicts an alternate installation method for the Scene Switch. This installation allows the CL2 communication leads to be routed through the electrical box.

**CAUTION: It is the Installers responsibility to ensure proper installation and compliance with the provisions of NEC Article 725. All Class 2 communication and multi-way switching conductors entering the wall box must be completely insulated.**

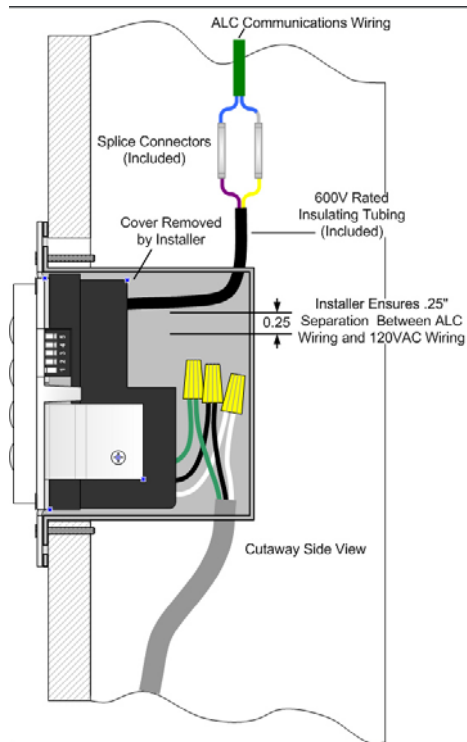

Figure 10. Alternate Installation Method

For further instructions on Scene Switch operation within other system environments, consult the controller's operating manual.

### Programming a Lighting Scene

Press and hold the button to be programmed for approximately 15 seconds until the Scene Switch's LED indicator flashes continuously. When the LED begins flashing, release the button to allow it to return to its normal state. The user then sets all lighting levels to be controlled by the lighting scene. The user must press each ALC Dimmer, Relay Switch or Non-Dimming control if it is to be included in the new local lighting scene program. The final output level of the selected ALC Dimmer, Relay Switch or Non-Dimming control will be stored in the local lighting scene program.

After setting all lighting levels of ALC switches that are intended to be included in the new local lighting scene program, the user should momentarily press and release the button to complete the programming operation. Programming of the new lighting scene is now completed and stored in the controller's memory.

While the system is in Scene Learning Mode, no other system functions may be performed during this time. If the user does not complete programming of the local lighting scene within 10 minutes, the system automatically leaves the Scene Learning Mode and no changes are made to any local lighting scenes.

### Restoring Local Lighting Scenes

To restore a locally programmed lighting scene, the user momentarily presses and releases the desired Scene Switch button. All ALC lighting controls belonging to that scene are then set to their programmed levels. ALC lighting controls not belonging to the scene are not affected when the scene is restored.

### IR Scene Operation

The part no. 364776 Designer IR Scene Switch can be controlled with an Infrared Remote control to restore locally programmed lighting scenes. The part no. 364820-01 universal IR learning remote control incorporates four factory programmed buttons that transmit the IR control codes. To transmit the IR codes, press the AUX button and then press 1, 2, 3 or 4. "1" will restore the scene programmed on the top button of the Scene Switch; "2" will restore the scene programmed on the 2<sup>nd</sup> button from the top, and so on... Scenes cannot be programmed from the remote control.

### Re-Programming Local Lighting Scenes

To change the ALC lighting controls or levels that are included in a scene, the user simply repeats the scene programming process. The lighting levels for the new local lighting scene will replace the old ones. To remove a local lighting scene from any button or input, simply enter Scene Learning Mode then press that button or input again without changing any lighting levels. That button or input will then be assigned an "empty" scene.

### 5. Warranty

Stewart Electronics warrants to the end-user, each new ALC module to be free of defects in materials or workmanship for a period of one year from the date of original purchase from Stewart Electronics or its authorized reseller or installer. Each product is deemed warrantable under conditions of normal use and when installed and operated within Stewart Electronics specifications and in accordance with the applicable National Electrical Code and Safety Standards of Underwriters Laboratories. When determined to be warrantable, Genesis shall at its option and expense, replace any defective product with a new or reconditioned product. Stewart Electronics will continue to warrant any replaced product for a period of ninety (90) days from shipment, or through the end of the original warranty period, whichever is longer.

### NEC Rules and Advanced Lighting Control Switch Installation

The scope of 2005 NEC Section 725.55(D) specifically addresses the installation of Class 2 circuit conductors with the conductors of electric light and power circuits within the same device box (wall box). Section 725.55(D) states that the conductors of electric light and power circuits are permitted to be installed within the same device box as Class 2 circuit conductors when the conductors of electric light and power circuits are routed to maintain a minimum of 0.25 in. separation from the conductors and cables of the Class 2 circuits. Alternatively, the Class 2 circuit conductors may be separated from the electric light and power circuit conductors by a non-conductive sleeve.

### 4. Operation

The programming of a lighting scene or system mode varies depending upon the specific controller that the Scene Switch is connected to. The following instructions assume that the Scene Switch is connected to an Genesis Home Lighting Controller or HMS EZ-Scene ALC Lighting Interface.